



GB Instruction for use
SE Bruksanvisning



POWERTEX Chain Block model PCB-S1

POWERTEX Chain Block PCB-S1 0.25 – 10 tonnes Instruction for use (GB) (Original instructions)

Read through these user instructions carefully before using the chain block. Improper operation may lead to hazardous situations!

General safety provisions

- Check the function of the chain block before use. See “Daily checks” on page 3.
- Full function of the brake system can only be secured at a minimum load of 30 kg for capacities (WLL) up to 1 ton, and for capacities (WLL) above 1 ton, the minimum load to be greater than 3% of the rated capacity (WLL).
- Do not exceed the maximum load.
- Handle the chain block with care. Do not throw the block about or let it fall to the ground.
- Do not use the chain block for welding work where it is exposed to welding spatter or current.
- The chain block must not be used for lifting persons.

Technical data

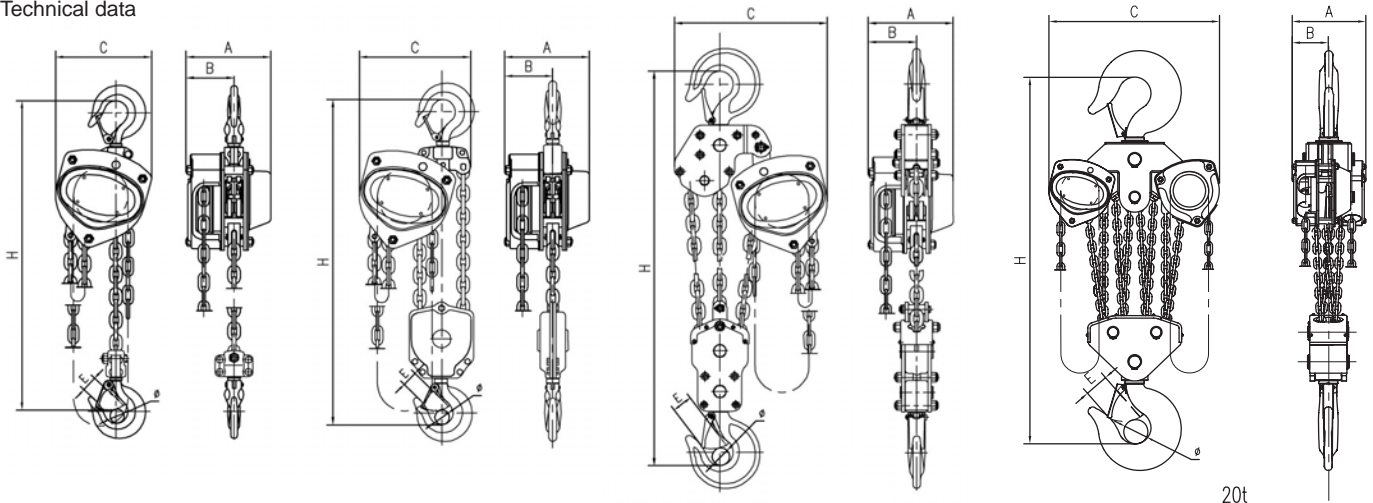

Model	PCB-S1	PCB-S1	PCB-S1	PCB-S1	PCB-S1	PCB-S1	PCB-S1	PCB-S1
Max. Load tonnes	0,25	0,5	1	2	3	5	10	20
Standard lifting height *) m	3	3	3	3	3	3	3	3
Number of block falls	1	1	1	1	1	2	3	8
Pull on hand chain daN (kp)	19	21	29	36	41	40	46	2x40
Load chain	4x12	5x15	6,3x19	8x24	10x30	9x27	10x30	9x27
Dimension A mm	106	128	142	175	195	183	195	183
Dimension B mm	68	75	76	88	95	90	95	90
Dimension C mm	108	130	150	185	226	255	355	577
Dimension Ø mm	18	20	25	33	36	43	44	110
Dimension E mm	20	22	26	35	37	44	47	70
Dimension H min. mm	280	330	360	470	560	690	810	1.060
Weight for standard lift height kg	6,4	8,9	12	19,5	29,4	36,6	64,1	185

*) Length of hand chain varies according to lifting height.

Safety factor: 4:1.

Static test coefficient: WLL x 1,5.

Generally according to EN 13157.

Function

The load hook is raised or lowered by pulling on the hand chain. The load will remain where it is even when the hand chain is released because of the effective reaction brake.

Suspension of chain block

Suspend the block from an eye, shackle, girder trolley etc. with sufficient load capacity. With the chain tightened, both hooks must be vertically aligned.



NB! No bending stresses may be applied to block, hooks or load chain.

Raising/lowering

Only use straps and slings of sufficient load capacity. Check that the load is not anchored to the floor/ground or is otherwise fixed before making the lift. Ensure that the load chain hangs vertically and has no kinks. The hand chain must also be in good condition and easily accessible. The load is raised or lowered by pulling the hand chain in either direction.

Warning:

- Only hand power from a single person is permitted on the hand chain. If the chain feels too heavy, use a bigger chain block or reduce the load.
- Make sure no-one stands beneath a hanging load.
- Do not step onto a hanging load.
- Do not raise or lower so far that the load hook hits the block housing.
- The chain block must not be used for pulling loads.
- The block must not be subjected to dynamic stresses, for example where a load connected to the block is launched from a height.
- Do not leave a block with a suspended load unattended.

Attachment of loads

Check the equipment before use. Improper attachment of loads can be highly dangerous (see Figs. 2 a – 2 e).



Fig 2 a
The sling is applying load to the hook tip

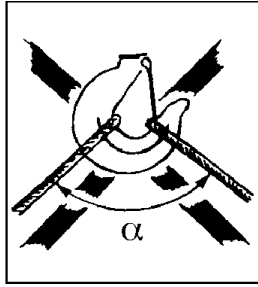

Fig 2 b
Excessive top angle on sling!
 α max 60°

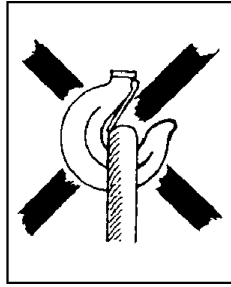

Fig 2 c
Hook latch obstructed

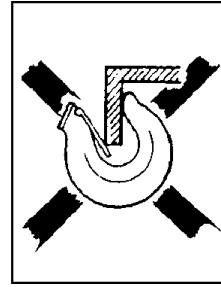

Fig 2 d
Hook tip subject to additional bending stress

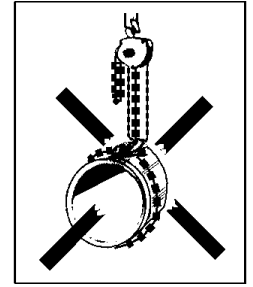

Fig 2 e
Load chain must not be used as a sling

Multiple lifting

Multiple lifting presents special risks. This is when two or perhaps more hoists are used simultaneously for the same load. Danger to persons and material damage can arise due to dynamic stresses and uneven load distribution causing individual hoists to become overloaded. A competent person with experience in multiple lifting must therefore supervise this type of lifting tasks.

The total weight of the target object and its load distribution must be known or calculated.

For a variety of reasons, the centre of gravity can be difficult to determine, and thus so will the distribution of the load each hoist must bear. In cases where heavy, bulky loads must be handled and it is not possible to estimate all factors correctly, the max working load limit (WLL) of each hoist must be reduced by at least 25%.

Daily checks

After every working day on which the chain block has been used, the following should be checked:

- Is the chain block deformed or otherwise damaged? Are any parts missing?
- Is any deformation or other damage visible on the suspension device (eye, shackle, bolt, trolley etc.)?
- Are the hooks intact or have any hooks opened? Are the hook latches correct and functional?
- Wipe down the chain block and oil the load chain as required.
- The load chain must be undamaged, i.e. no signs of wear and no deformed or otherwise damaged links.
- The load chain must not be kinked or twisted. With two-fall or multi-fall chain blocks there is a risk of the chain twisting if the bottom hook assembly ends up looped through the chain sling – usually during refitting or moving the chain block between work stations. See Fig 3.
- The hand chain must also be in good condition.
- The brake function must be intact.

In the event of faults or failures, the block must be repaired and carefully checked by a specialist before reuse.

Continuous maintenance - lubrication

Oil the hook latches and bearings. Grease the pawl and ratchet and also the gear. Lubrication must be sparingly and carefully applied so no grease gets on the brake disk. Oil the load chain for longer life.

Periodic checks

Periodic checks are normally carried out yearly to detect and remedy any faults. If required (e.g. high frequency of use), more frequent checks may be carried out. See "Checklist for periodic checks". Measure hooks and chain to detect any changes in shape.

Checks on load hook (see Fig. 4 and Table 1)

Opening dimension I on the hooks is important. A hook with too large a maximum dimension has been exposed to overloading or overheating. It therefore does not have the necessary load capacity. The hooks may also have been exposed to long-term wear (dimension K).

Hooks must be discarded and replaced if:

- The maximum I value is exceeded (according to Table 1)
- The minimum K value falls short (according to Table 1)
- The hook shows signs of cracking
- The hook is deformed or otherwise damaged

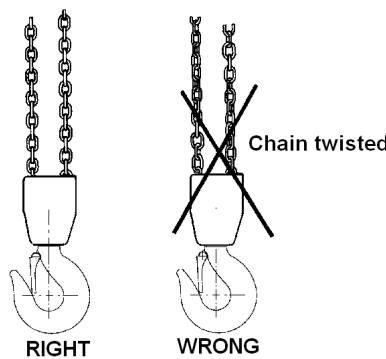

Fig. 3 The chain must not be twisted

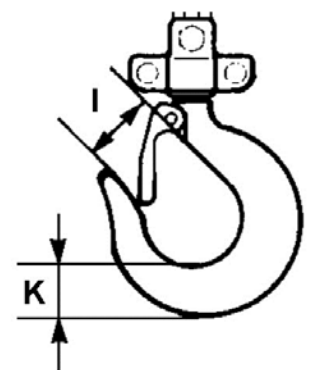

Fig. 4 Load hook

Defective hooks must be replaced before using the chain block again.

Table 1 Load hook

Max. load t	0,25	0,5	1	2	3	5	10	20
Model	PCB-S1	PCB-S1	PCB-S1	PCB-S1	PCB-S1	PCB-S1	PCB-S1	PCB-S1
Dimension I nominal mm	24	25,5	30	38,5	41,5	47	55	84
Dimension I max mm	26,4	28,0	33	42,3	45,5	51,7	60,5	92,4
Dimension K nominal mm	15	19	25	33,5	39	44,5	62	93
Dimension K min mm	13,5	17,1	22,5	30,2	35,1	40,0	55,8	83,7

Checks on load chain (see Fig. 5 and Table 2)

Inspect the load chain over its whole length to detect any deformed or otherwise damaged links. Make a check measurement of suspect links. Measure the worn areas Also, every 300 mm (normally), make check measurements of the internal length of 5 links (pitch dimension 5xP – according to Table 2).

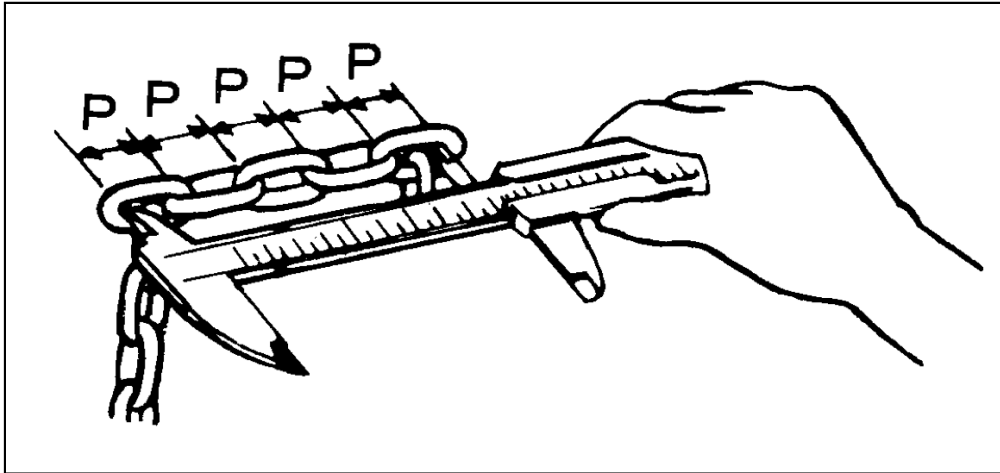

Fig 5 Checking chain dimensions

Table 2 Load chain

Max. load t	0,25	0,5	1	2	3	5	10	20
Model	PCB-S1	PCB-S1	PCB-S1	PCB-S1	PCB-S1	PCB-S1	PCB-S1	PCB-S1
Link diameter nominal mm	4,0	5,0	6,3	8,0	10,0	9,0	10,0	9,0
Link diameter min. mm	3,6	4,5	5,7	7,2	9,0	8,1	9,0	8,1
Pitch dimension (5xP) nominal mm	60,0	75,0	95,0	120,0	150,0	135,0	150,0	135,0
Pitch dimension (5xP) max. mm	61,8	77,2	98,0	123,5	154,5	139,0	154,5	139,0

The load chain must be discarded and replaced if:

- cracks are detected on any link
- any link is deformed or otherwise damaged
- The minimum value of any link's diameter falls short
- the maximum value of the pitch dimension is exceeded at any point
- the chain is damaged by overheating or has been affected by weld splatter

Load chains must **not** be repaired – they must be replaced by new chain. If it is desired to lengthen the chain, it must be replaced by a new and longer chain.

Replacement of the chain shall be performed professionally by an authorized repairer and the chain must meet the requirements stated in the standard EN 818-7 from the following manufacturers: Chaineries Limousines, Pewag, Thiele or Rud.

Repairs

The chain block must not be modified. Repairs must be carried out by specialists. Damaged parts must only be replaced with original Powertex spare parts. Order them through your dealer.

Checklist for periodic checks (normally yearly – more frequently if necessary)

Daily	Yearly	Inspection items	Inspection method	Note
Labels				
X	X	Rating plate	Visual	If the plate is hard to read - replace it
Function				
X	X	Raising and lowering function	Test without load	A low snapping noise should be audible
-	X	Raising and lowering function	Test with rated weight for min 300 mm	Load chain sprocket and chain work well together. Brake works. Hand pulling on the hand chain feels even and not too heavy
Hooks				
X -	X	Hook opening	Visual Measurements	Looks normal See Fig. 4 and Table 1
X	X	Deformation	Visual	No visible deformation
	X	Hook bearing	Visual	No abnormal play
X -	X	Wear, cracks, deformation and corrosion	Visual Measurements	No visible damage See Fig. 4 and Table 1
	X	Hook bearing	Visual	No abnormal play
Load chain				
X -	X	Pitch	Visual Measurement	Looks normal. Measure in case of doubt See Fig. 5 and Table 2
X -	X	Wear	Visual Measurement	Looks problem-free. Measure in case of doubt See Fig. 5 and Table 2
X	X	Deformation	Visual	No deformation. Measure in case of doubt
X	X	Cracks etc.	Visual	No cracks
X	X	Rust	Visual	No rust
Housing				
X	X	Frame	Visual	No deformation and no rust
X	X	Gearbox	Visual	No deformation
-	X	Gears	Visual after dismantling	No serious wear or fractures
-	X	Load chain sprocket	Visual after dismantling	No serious wear or cracks. No fractures or deformation
-	X	Hand chain sprocket	Visual	No serious wear or cracks. No fractures or deformation
-	X	Bearings	Visual, testing	No damage, smooth running
Screws				
	X	Screws, nuts, rivets, cotters etc.	Visual	Must not be missing. Tighten loose items. Replace as necessary
Brake				
-	X	Brake disk	Visual	Replace if worn
-	X	Brake screw	Visual	No serious wear
-	X	Pawl and ratchet	Visual	Replace worn parts. Carefully lubricate with grease

POWERTEX lyftblock PCB-S1 0,25 – 10 ton Bruksanvisning (SE)

Läs igenom denna bruksanvisning innan lyftblocket tas i bruk. Felaktig användning kan innebära fara!

Allmänna säkerhetsanvisningar

- Kontrollera lyftblockets funktion före användning. Se: "Daglig kontroll" sidan 7.
- Full funktion av bromssystemet kan bara säkras vid en minsta last av på 30 kg för en kapacitet (WLL) upptill 1 ton. För kapacitet (WLL) över 1 ton skall minsta lasten vara mera än 3% av nominell kapacitet (WLL)
- Belasta inte med mer än maxlasten.
- Hantera lyftblocket varsamt. Kasta inte och släpa inte blocket.
- Använd inte lyftblocket vid svetsningsarbeten så att det kan bli utsatt för svetsstänk eller svetsström.
- Lyftblocket får ej användas för personlyft.

Tekniska data

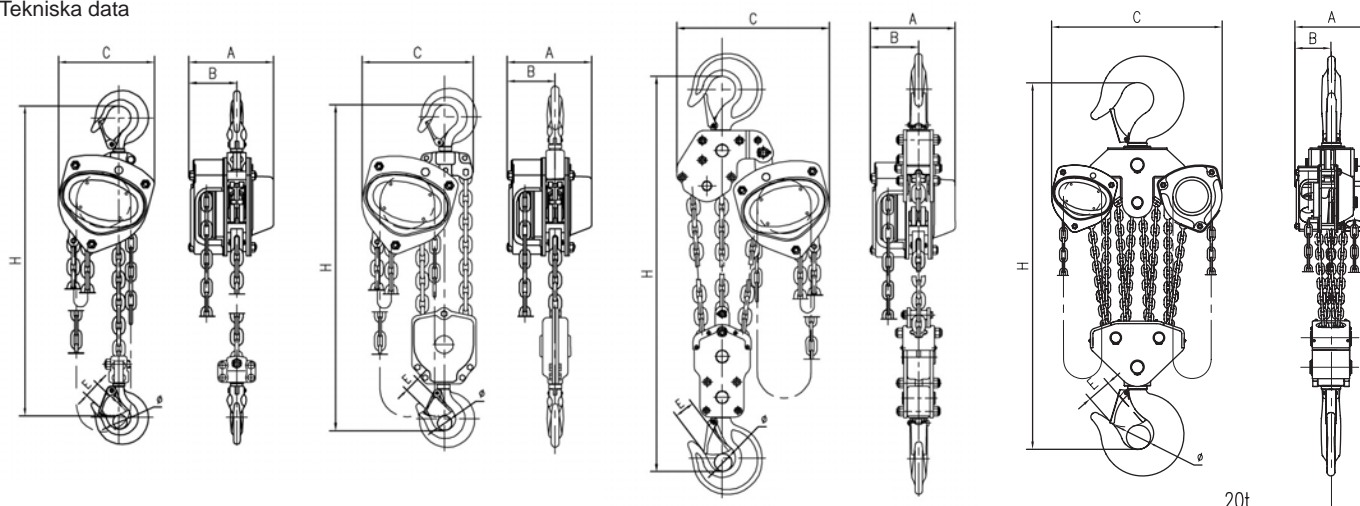

Modell	PCB-S1	PCB-S1	PCB-S1	PCB-S1	PCB-S1	PCB-S1	PCB-S1
Maxlast ton	0,25	0,5	1	2	3	5	10
Standard lyfthöjd *) m	3	3	3	3	3	3	3
Antal lyftparter	1	1	1	1	1	2	3
Kraft i manöverkättingen daN (kp)	19	21	29	36	41	40	54
Lastkätting mm	4x12	5x15	6,3x19,1	8x24	10x30	9x27	10x30
Mått A mm	106	128	142	175	195	183	195
Mått B mm	68	75	76	88	95	90	95
Mått C mm	108	130	150	185	226	255	355
Mått Ø mm	18	20	25	33	36	43	44
Mått E mm	20	22	26	35	37	43	47
Mått H min mm	280	280	330	385	435	615	810
Vikt med standard lyfthöjd kg	6,4	8,9	12	19,5	29,4	36,3	64,1

*) Manöverkättingens längd är anpassad efter lyfthöjden.

Säkerhetsfaktor: 4:1.

Statisk provkoefficient: WLL x 1,5.

Generellt i överensstämmelse med EN 13157.

Funktion

Lastkroken lyfts eller sänks genom att man drar i manöverkättingen. Lasten hänger kvar även om man släpper manöverkättingen tack vare en effektiv lasttrycksbroms.

Upphängning av lyftblocket

Blocket hängs upp i ögla, schackel, blockvagn på balk etc med tillräcklig bärlighet. När kättingen stramats upp ska de båda krokarna vara vertikalt i linje med varandra.



OBS! varken block, krokar eller lastkätting får utsättas för böjpåkänning.

Lyft/sänk

Använd endast stroppar och sling med tillräcklig bärlighet. Kontrollera att lasten inte är förankrad i golvet/marken eller fast på annat sätt när lyftet skall ske. Se till att lastkättingen hänger vertikalt och utan kinkar. Manöverkättingen skall också vara i god ordning och lättåtkomlig. Lasten lyfts respektive sänks när man drar i manöverkättingen åt endera hållet.

Varning:

- Endast handkraft från en man på manöverkättingen är tillåten! Om det känns för tungt välj ett större lyftblock eller reducera lasten!
- Se till att ingen befinner sig under hängande last!
- Stå ej på hängande last!
- Lyft och sänk inte för långt så att lastkroken går emot blockets hus!
- Lyftblocket får ej användas för dragning av last.
- Blocket får inte utsättas för dynamisk påkänning exempelvis genom att en till blocket kopplad last knuffas ut från en höjd!
- Lämna inte blocket med hängande last oöversatt!

Lastkoppling

Kontrollera utrustningen före användning. Felaktig lastkoppling kan vara mycket farlig (se fig 2 a – 2 e).



Fig 2 a
Slinget belastar
krokspetsen!

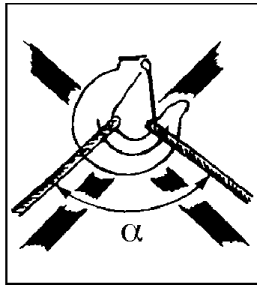

Fig 2 b
För stor toppvinkel
på slinget!
 α max 60°

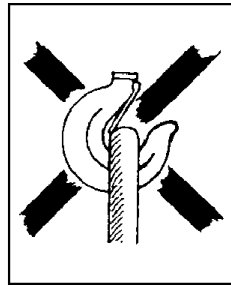

Fig 2 c
Krokspärren
blockerad!

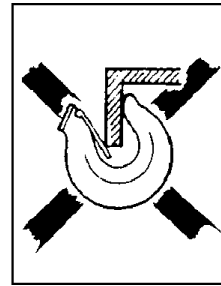

Fig 2 d
Krokspetsen dessutom
utsatt för böjpåkänning!

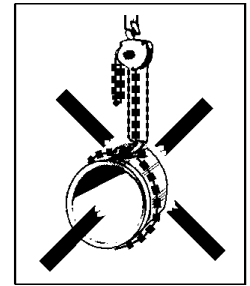

Fig 2 e
Lastkättingen
får ej användas
som sling!

Lyft med flera lyftanordningar

Lyft med flera lyftanordningar medför särskilda risker. Med detta avses att två eller flera lyftanordningar används samtidigt för samma last. Fara för personer samt materiella skador kan uppstå på grund av dynamisk belastning och ojämn lastfördelning som leder till att enskilda lyftanordningar överbelastas. En kvalificerad person med erfarenhet av lyft med flera lyftanordningar måste därför övervaka denna typ av lyftarbeten. Totalvikten för objektet som ska lyftas och dess lastfördelning måste vara kända eller beräknas.

Tyngdpunkten kan av flera olika skäl vara svår att fastställa och därmed även fördelningen av lasten som varje kedjelyftblock måste bära. I fall där tung och skrymmande last måste hanteras och det inte är möjligt att uppskatta alla påverkande faktorer korrekt måste den högsta tillåtna belastningen (WLL) för varje kedjelyftblock minskas med minst 25%.

Daglig kontroll

Efter varje arbetsdag som lyftblocket använts kontrolleras följande:

- Har lyftblocket blivit deformerat eller fått andra skador? Saknas någon eller några delar?
- Syns det någon deformation eller annan skada på upphängningsanordningen (öglå, schackel, bult, blockvagn etc)?
- Är krokarna intakta eller har någon krok öppnats? Är krokspärrarna felfria och funktionsdugliga?
- Lyftblocket torkas av och lastkättingen anoljas vid behov.
- Lastkättingen skall vara oskadad v s ej sliten eller ha deformerade eller på annat sätt skadade länkar.
- Lastkättingen får inte ha kinkar och ej heller vara vriden. För 2- eller flerpartigt lyftblock finns risken att kättingen blir vriden genom att underblocket råkar bli vänt igenom kättingslingan – oftast vid ommontering eller flyttning av lyftblocket mellan olika arbetsställen. Se fig 3.
- Även manöverkättingen skall vara i god ordning.
- Bromsfunktionen skall vara intakt.

I händelse av fel eller brister skall blocket repareras och noggrant kontrolleras av fackman innan det tas i bruk igen.

Fortlöpande underhåll – smörjning

Anolja krokspärrar och -lagringar. Spärrhake och -hjul samt växel smörjs med fett. Smörjning skall ske sparsamt och försiktigt så att det inte kommer smörjmedel på bromsskivan. Lastkättingen anoljas för längre livslängd.

Regelbunden kontroll

Regelbunden kontroll utförs normalt årligen för att eventuella brister skall upptäckas och åtgärdas. Vid behov (t ex hög användningsfrekvens) utförs tätare kontroll. Se "Checklista för regelbunden kontroll". Krokarna och kätting mäts för att upptäcka eventuella formförändringar.

Kontroll av lastkrok (se fig 4 och tabell 1)

Krokarnas öppningsmått I är viktigt. En krok med för stort maxmått har varit utsatt för överbelastning eller upphettning. Den har därför inte tillräcklig bärighet. Krokarna kan även ha blivit utsatta för långvarigt slitage (mått K).

En krok skall skrotas och bytas ut mot ny om:

- I-måttets maxvärde överskrids (enligt tabell 1)
- K-måttets minvärde underskrids (enligt tabell 1)
- Kroken har någon spricka
- Kroken blivit deformerad eller på annat sätt skadad

Defekt krok skall bytas innan lyftblocket används igen!

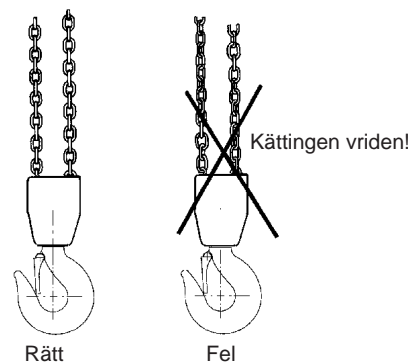

Fig 3 Kättingen får ej vara vriden

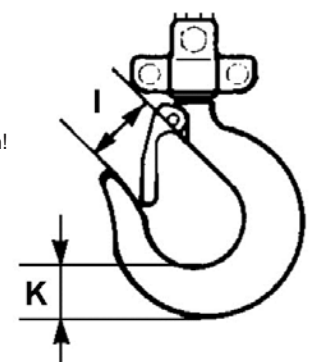

Fig 4 Lastkrok

Tabell 1 Lastkrok

Maxlast ton	0,25	0,5	1	2	3	5	10	20
För modell	PCB-S1	PCB-S1	PCB-S1	PCB-S1	PCB-S1	PCB-S1	PCB-S1	PCB-S1
Mått I nominellt mm	24	25,5	30	38,5	41,5	47	55	84
Mått I max mm	26,4	28,0	33	42,3	45,5	51,7	60,5	92,4
Mått K nominellt mm	15	19	25	33,5	39	44,5	62	93
Mått K min mm	13,5	17,1	22,5	30,2	35,1	40,0	55,8	83,7

Kontroll av lastkätting (se fig 5 och tabell 2)

Granska lastkättingen utefter hela längden för att upptäcka eventuella deformerade eller på annat sätt skadade länkar. Misstänkta länkar kontrolleras. Mät på slitställena. Kontrollmät även varje 300 mm (i normalfall) den invändiga längden av 5 länkar (delningsmättet 5xP – enligt tabell 2).

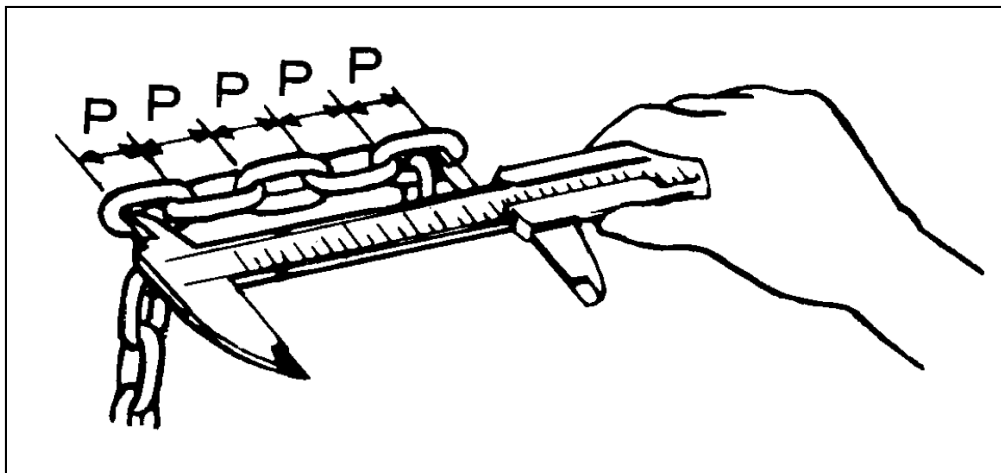

Fig 5 Kontrollmätning av lastkätting

Tabell 2 Lastkätting

Maxlast ton	0,25	0,5	1	2	3	5	10	20
För modell	PCB-S1	PCB-S1	PCB-S1	PCB-S1	PCB-S1	PCB-S1	PCB-S1	PCB-S1
Länkdiameter nominellt mm	4,0	5,0	6,3	8,0	10,0	9,0	10,0	9,0
Länkdiameter min mm	3,6	4,5	5,7	7,2	9,0	8,1	9,0	8,1
Delningsmått (5xP) nominellt mm	60,0	75,0	95,0	120,0	150,0	135,0	150,0	135,0
Delningsmått (5xP) max mm	61,8	77,2	98,0	123,5	154,5	139,0	154,5	139,0

Lastkättingen skall skrotas och bytas ut mot ny om:

- någon spricka upptäcks på någon länk
- någon länk blivit deformerad eller på annat sätt skadad
- minvärdet hos någon länks diameter underskrids
- maxvärdet för delningsmättet någonstans överskrids
- kättingen blivit skadad genom upphettning eller har fått svetsstänk

Lastkätting får **ej** repareras – den måste bytas ut mot ny originalkätting. Om kättingen önskas längre måste den bytas ut mot en ny som är längre.

Byte av kätting skall utföras fackmässigt av auktoriserad reparatör och kättingen skall uppfylla krav ställda i standard EN 818-7 från följande fabrikat: Chaineries Limousines, Pewag, Thiele eller Rud.

Reparationer

Lyftblocket får **inte** byggas om. Reparationer skall utföras av fackman. Byt ut skadade delar endast mot Powertex original reservdelar. Beställ genom återförsäljaren.

Checklista för regelbunden kontroll (normalt årligen – tätare vid behov)

Dagligen	Årligen	Kontrollpunkter	Kontrollmetod	Observera
Märkning				
X	X	Typskylt	Okulärt	Om skylten är svårläst – byt
Funktion				
X	X	Lyft- och sänkfunktion	Prova utan last	Mjukt snäppande ljud skall höras
-	X	Lyft- och sänkfunktion	Prova med märk-lasten utefter min 300 mm	Kothjul och kätting fungerar bra ihop. Bromsen fungerar. Handkraften i manöverkättingen är jämn och ej för stor
Krokar				
X -	X	Kroköppning	Okulärt Mät	Ser normal ut Se fig 4 och tabell 1
X	X	Deformation	Okulärt	Ingen synlig deformation
	X	Kroklagring	Okulärt	Inget onormalt glapp
X -	X	Slitage, sprickor, deformation och korrosion	Okulärt Mät	Inga synliga skador Se fig 4 och tabell 1
	X	Krokspärrar	Okulärt, prova	Fungerar, fjädern hel
Lastkätting				
X -	X	Delningen	Okulärt Mät	Ser normal ut. Mät vid tveksamhet Se fig 5 och tabell 2
X -	X	Slitage	Okulärt Mät	Ser felfri ut. Mät vid tveksamhet Se fig 5 och tabell 2
X	X	Deformation	Okulärt	Ingen deform. Mät vid tveksamhet
X	X	Sprickor m m	Okulärt	Inga sprickor
X	X	Rost	Okulärt	Ingen rost
Hus				
X	X	Huset	Okulärt	Ingen deformation och ingen rost
X	X	Växelhus	Okulärt	Ingen deformation
-	X	Växel	Okulärt efter demont	Inget allvarligt slitage eller brott
-	X	Kothjul	Okulärt efter demont	Inget allvarligt slitage, eller sprickor. Inga brott eller deformationer
-	X	Manöverkättinghjul	Okulärt	Inget allvarligt slitage, eller sprickor. Inga brott eller deformationer
-	X	Lagringar	Okulärt, prova	Utan skador, fungerar lätt
Skrubar				
	X	Skrubar, muttrar, nitar, sprintar m m	Okulärt	Får inte saknas. Lösa dras åt. Byt vid behov
Broms				
-	X	Bromsskiva	Okulärt	Sliten bromsskiva byts
-	X	Bromsskruv	Okulärt	Fri från allvarligt slitage
-	X	Spärrhake och -hjul	Okulärt	Byt slitna delar. Smörj försiktigt med fett.

POWERTEX Chain Block PCB-S1 – Spare parts 0,25 t

When ordering spare parts, specify model, WLL, part number and the quantity needed.

When ordering chain, also specify lifting height.

If the load chain has been damaged or worn out the load sheave probably has to be replaced.

POWERTEX Chain Block 0,25 t

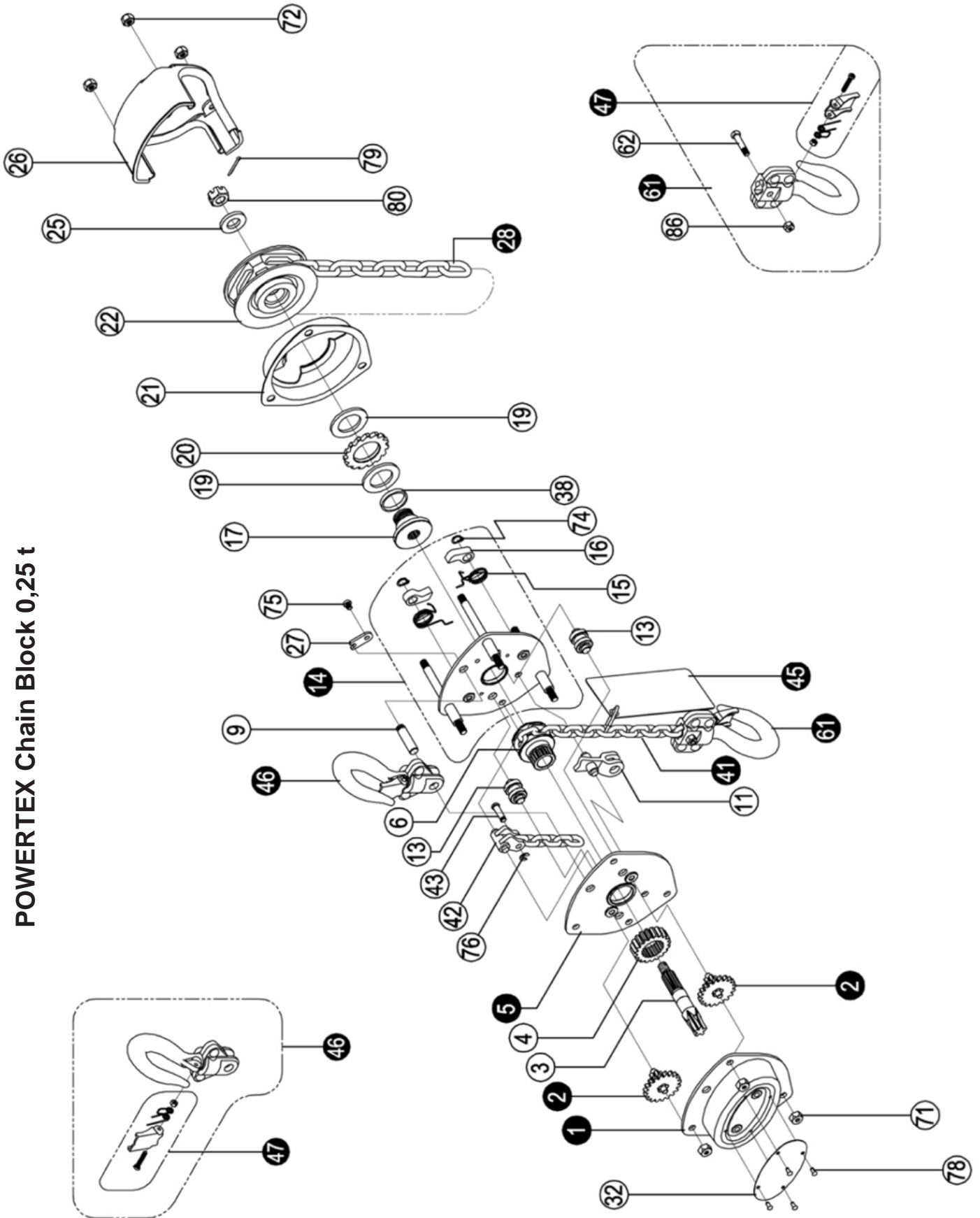

Spare parts list 0,25 t

Pos	Description	0,25 t
1	Gear cover assy	16.10PCB1411001
2	Disc gear assy	16.10PCB1411002
3	Drive shaft	16.10PCB1411003
4	Splined gear	16.10PCB1411004
5	Right side plate assy	16.10PCB1411005
6	Load chain sprocket	16.10PCB1411006
9	Top hook shaft	16.10PCB1411009
11	Chain stripper	16.10PCB1411011
13	Guide roller	16.10PCB1411013
14	Left side plate assy	16.10PCB1411014
15	Pawl spring	16.10PCB1411015
16	Pawl	16.10PCB1411016
17	Brake seat	16.10PCB1411017
19	Friction plate	16.10PCB1411019
20	Ratchet wheel	16.10PCB1411020
21	Brake cover	16.10PCB1411021
22	Hand chain wheel	16.10PCB1411022
25	Washer	16.10PCB1411025
26	Hand chain cover	16.10PCB1411026
27	Positioned plate	16.10PCB1411027
28	Hand Chain	16.10PCB1411028
32	Name plate	16.10PCB1411032
41	Load Chain	16.10PCB1411041
42	End anchor	16.10PCB1411042
43	End anchor pin	16.10PCB1411043
45	Warning plate assy	16.10PCB1411045
46	Top hook assy	16.10PCB1411046
47	Safety latch assy	16.10PCB1411047
61	Bottom hook assy	16.10PCB1411061
62	Bottom hook pin	16.10PCB1411062
71	Metal lock nut	16.10PCB1411071
72	Metal lock nut	16.10PCB1411072
74	Circlip	16.10PCB1411074
75	Cross head screw	16.10PCB1411075
76	Split retainer	16.10PCB1411076
78	Name plate	16.10PCB1411078
79	Split pin	16.10PCB1411079
80	Hexagon nut	16.10PCB1411080

POWERTEX Chain Block PCB-S1 – Spare parts 0,5 – 5 t

When ordering spare parts, specify model, WLL, part number and the quantity needed.

When ordering chain, also specify lifting height.

If the load chain has been damaged or worn out the load sheave probably has to be replaced

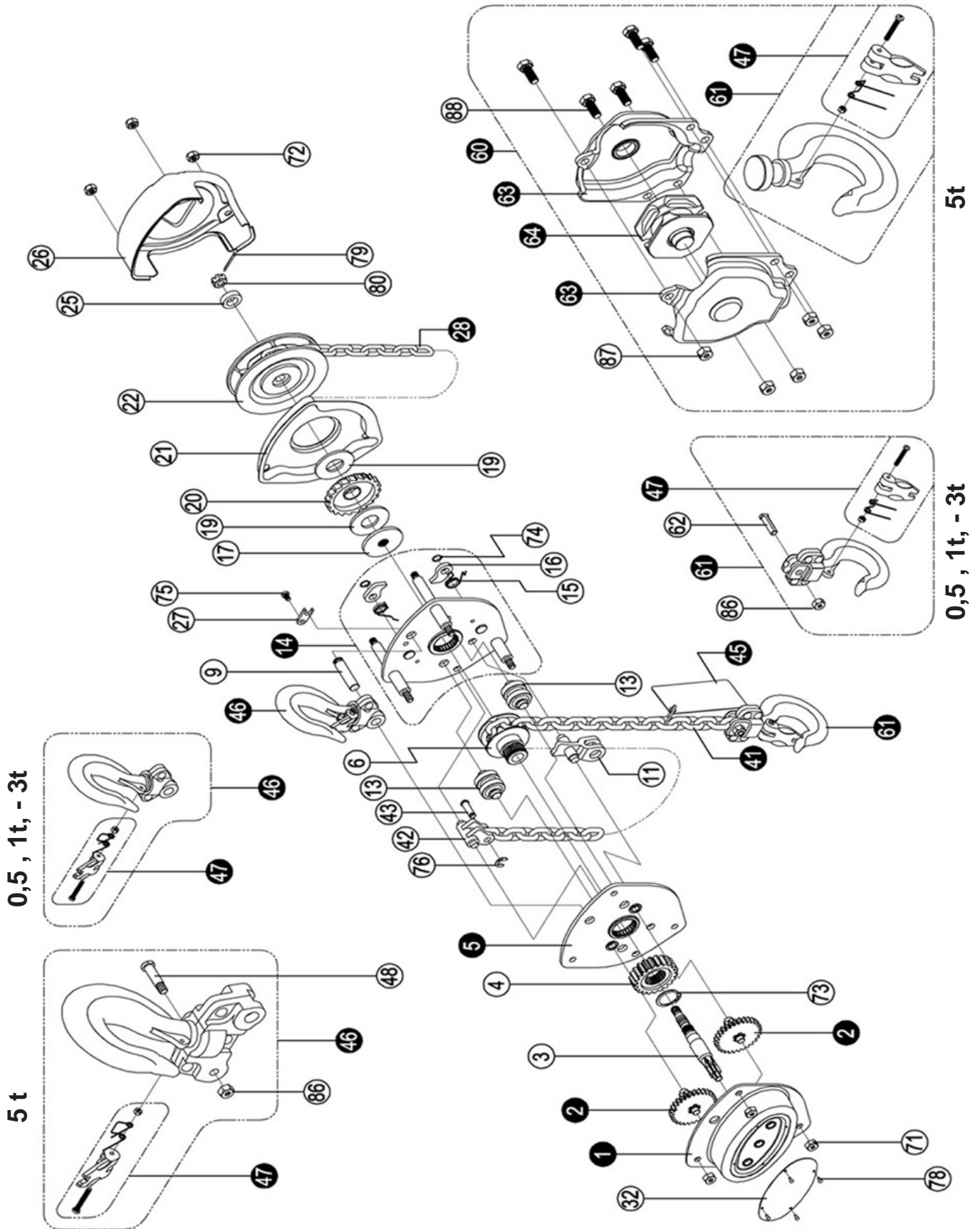

Spare parts list 0,5 – 5 t

Pos	Description	0,5 t	1 t	2 t	3 t	5 t
1	Gear cover assy	16.10PCB1412001	16.10PCB1414001	16.10PCB1416001	16.10PCB1417001	16.10PCB1419001
2	Disc gear assy	16.10PCB1412002	16.10PCB1414002	16.10PCB1416002	16.10PCB1417002	16.10PCB1419002
3	Drive shaft	16.10PCB1412003	16.10PCB1414003	16.10PCB1416003	16.10PCB1417003	16.10PCB1419003
4	Splined gear	16.10PCB1412004	16.10PCB1414004	16.10PCB1416004	16.10PCB1417004	16.10PCB1419004
5	Right side plate assy	16.10PCB1412005	16.10PCB1414005	16.10PCB1416005	16.10PCB1417005	16.10PCB1419005
6	Load chain sprocket	16.10PCB1412006	16.10PCB1414006	16.10PCB1416006	16.10PCB1417006	16.10PCB1419006
9	Top hook shaft	16.10PCB1412009	16.10PCB1414009	16.10PCB1416009	16.10PCB1417009	16.10PCB1419009
11	Chain stripper	16.10PCB1412011	16.10PCB1414011	16.10PCB1416011	16.10PCB1417011	16.10PCB1419011
13	Guide roller	16.10PCB1412013	16.10PCB1414013	16.10PCB1416013	16.10PCB1417013	16.10PCB1419013
14	Left side plate assy	16.10PCB1412014	16.10PCB1414014	16.10PCB1416014	16.10PCB1417014	16.10PCB1419014
15	Pawl spring	16.10PCB1412015	16.10PCB1414015	16.10PCB1416015	16.10PCB1417015	16.10PCB1419015
16	Pawl	16.10PCB1412016	16.10PCB1414016	16.10PCB1416016	16.10PCB1417016	16.10PCB1419016
17	Brake seat	16.10PCB1412017	16.10PCB1414017	16.10PCB1416017	16.10PCB1417017	16.10PCB1419017
19	Friction plate	16.10PCB1412019	16.10PCB1414019	16.10PCB1416019	16.10PCB1417019	16.10PCB1419019
20	Ratchet wheel	16.10PCB1412020	16.10PCB1414020	16.10PCB1416020	16.10PCB1417020	16.10PCB1419020
21	Brake cover	16.10PCB1412021	16.10PCB1414021	16.10PCB1416021	16.10PCB1417021	16.10PCB1419021
22	Hand chain wheel	16.10PCB1412022	16.10PCB1414022	16.10PCB1416022	16.10PCB1417022	16.10PCB1419022
25	Washer	16.10PCB1412025	16.10PCB1414025	16.10PCB1416025	16.10PCB1417025	16.10PCB1419025
26	Hand chain cover	16.10PCB1412026	16.10PCB1414026	16.10PCB1416026	16.10PCB1417026	16.10PCB1419026
27	Positioned plate	16.10PCB1412027	16.10PCB1414027	16.10PCB1416027	16.10PCB1417027	16.10PCB1419027
28	Hand Chain	16.10PCB1412028	16.10PCB1414028	16.10PCB1416028	16.10PCB1417028	16.10PCB1419028
32	Name plate	16.10PCB1412032	16.10PCB1414032	16.10PCB1416032	16.10PCB1417032	16.10PCB1419032
41	Load Chain	16.10PCB1412041	16.10PCB1414041	16.10PCB1416041	16.10PCB1417041	16.10PCB1419041
42	End anchor	16.10PCB1412042	16.10PCB1414042	16.10PCB1416042	16.10PCB1417042	16.10PCB1419042
43	End anchor pin	16.10PCB1412043	16.10PCB1414043	16.10PCB1416043	16.10PCB1417043	16.10PCB1419043
45	Warning plate assy	16.10PCB1412045	16.10PCB1414045	16.10PCB1416045	16.10PCB1417045	16.10PCB1419045
46	Top hook assy	16.10PCB1412046	16.10PCB1414046	16.10PCB1416046	16.10PCB1417046	16.10PCB1419046
47	Safety latch assy	16.10PCB1412047	16.10PCB1414047	16.10PCB1416047	16.10PCB1417047	16.10PCB1419047
48	Top hook pin	-	-	-	-	16.10PCB1419048
60	Bottom hook assy	-	-	-	-	16.10PCB1419060
61	Bottom hook assy	16.10PCB1412061	16.10PCB1414061	16.10PCB1416061	16.10PCB1417061	16.10PCB1419061
62	Bottom hook pin	16.10PCB1412062	16.10PCB1414062	16.10PCB1416062	16.10PCB1417062	-
63	Bottom hook connector assy	-	-	-	-	16.10PCB1419063
64	Idler sheave assy	-	-	-	-	16.10PCB1419064
71	Metal lock nut	16.10PCB1412071	16.10PCB1414071	16.10PCB1416071	16.10PCB1417071	16.10PCB1419071
72	Metal lock nut	16.10PCB1412072	16.10PCB1414072	16.10PCB1416072	16.10PCB1417072	16.10PCB1419072
73	Circlip	16.10PCB1412073	16.10PCB1414073	16.10PCB1416073	16.10PCB1417073	16.10PCB1419073
74	Circlip	16.10PCB1412074	16.10PCB1414074	16.10PCB1416074	16.10PCB1417074	16.10PCB1419074
75	Cross head screw	16.10PCB1412075	16.10PCB1414075	16.10PCB1416075	16.10PCB1417075	16.10PCB1419075
76	Split retainer	16.10PCB1412076	16.10PCB1414076	16.10PCB1416076	16.10PCB1417076	16.10PCB1419076
78	Name plate	16.10PCB1412078	16.10PCB1414078	16.10PCB1416078	16.10PCB1417078	16.10PCB1419078
79	Split pin	16.10PCB1412079	16.10PCB1414079	16.10PCB1416079	16.10PCB1417079	16.10PCB1419079
80	Hexagon nut	16.10PCB1412080	16.10PCB1414080	16.10PCB1416080	16.10PCB1417080	16.10PCB1419080
86	Metal lock nut	16.10PCB1412086	16.10PCB1414086	16.10PCB1416086	16.10PCB1417086	16.10PCB1419086
87	Metal lock nut	16.10PCB1412087	16.10PCB1414087	16.10PCB1416087	16.10PCB1417087	16.10PCB1419087
88	Bolt M10x25	16.10PCB1412088	16.10PCB1414088	16.10PCB1416088	16.10PCB1417088	16.10PCB1419088

POWERTEX Chain Block PCB-S1 – Spare parts 10 t

When ordering spare parts, specify model, WLL, part number and the quantity needed.

When ordering chain, also specify lifting height.

If the load chain has been damaged or worn out the load sheave probably has to be replaced.

POWERTEX Chain Block 10 t

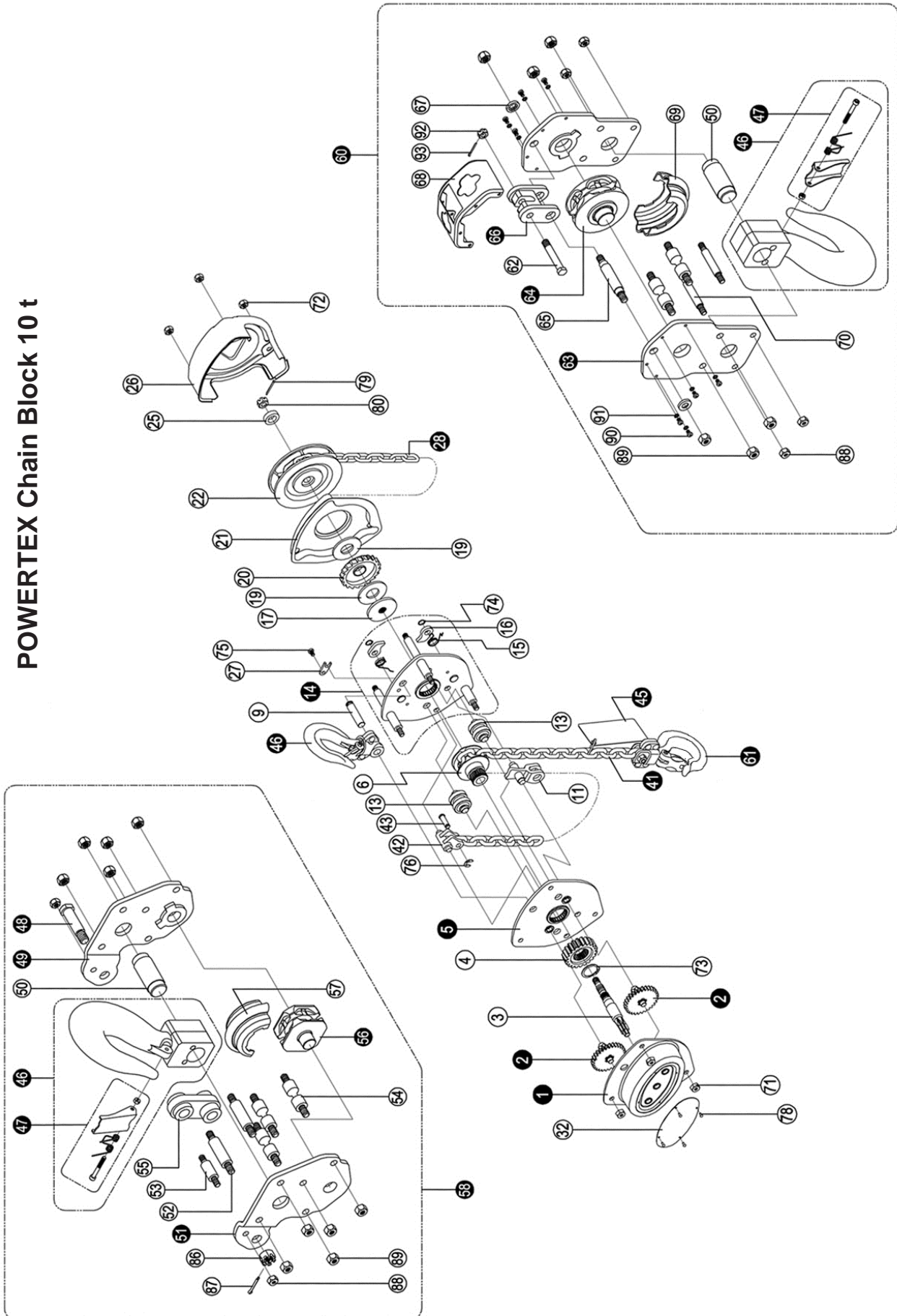

Spare parts list 10 t

Pos	Description	10 t	Pos	Description	10 t
1	Gear cover assy	16.10PCB1423001	54	Stay bolt B	16.10PCB1423054
2	Disc gear assy	16.10PCB1423002	55	Suspension plate	16.10PCB1423055
3	Drive shaft	16.10PCB1423003	56	Idler sheave assy	16.10PCB1423056
4	Splined gear	16.10PCB1423004	57	Protection cover	16.10PCB1423057
5	Right side plate assy	16.10PCB1423005	58	Top hook assy	16.10PCB1423058
6	Load chain sprocket	16.10PCB1423006	60	Bottom hook assy	16.10PCB1423060
9	Top hook shaft	16.10PCB1423009	62	Bottom hook pin	16.10PCB1423062
11	Chain stripper	16.10PCB1423011	63	Hook plate	16.10PCB1423063
13	Guide roller	16.10PCB1423013	64	Bottom idler sheave assy	16.10PCB1423064
14	Left side plate assy	16.10PCB1423014	65	Shaft	16.10PCB1423065
15	Pawl spring	16.10PCB1423015	66	Plate	16.10PCB1423066
16	Pawl	16.10PCB1423016	67	Washer	16.10PCB1423067
17	Brake seat	16.10PCB1423017	68	Protection cover	16.10PCB1423068
19	Friction plate	16.10PCB1423019	69	Cover	16.10PCB1423069
20	Ratchet wheel	16.10PCB1423020	70	Bolt	16.10PCB1423070
21	Brake cover	16.10PCB1423021	71	Metal lock nut	16.10PCB1423071
22	Hand chain wheel	16.10PCB1423022	72	Metal lock nut	16.10PCB1423072
25	Washer	16.10PCB1423025	73	Circlip	16.10PCB1423073
26	Hand chain cover	16.10PCB1423026	74	Circlip	16.10PCB1423074
27	Positioned plate	16.10PCB1423027	75	Cross head screw	16.10PCB1423075
28	Hand chain	16.10PCB1423028	76	Split retainer	16.10PCB1423076
32	Name plate	16.10PCB1423032	78	Name plate	16.10PCB1423078
41	Load chain	16.10PCB1423041	79	Split pin	16.10PCB1423079
42	End anchor	16.10PCB1423042	80	Hexagon nut	16.10PCB1423080
43	End anchor pin	16.10PCB1423043	86	Hexagon recess nut	16.10PCB1423086
45	Warning plate assy	16.10PCB1423045	87	Split pin	16.10PCB1423087
46	Top hook assy	16.10PCB1423046	88	Metal lock nut	16.10PCB1423088
47	Safety latch assy	16.10PCB1423047	89	Metal lock nut	16.10PCB1423089
48	Top hook pin	16.10PCB1423048	90	Cross head screw	16.10PCB1423090
49	Plate (right)	16.10PCB1423049	91	Light spring washer	16.10PCB1423091
50	Shaft	16.10PCB1423050	92	Hexagon recess nut	16.10PCB1423092
51	Plate (left)	16.10PCB1423051	93	Split pin	16.10PCB1423093
52	Stay bolt A	16.10PCB1423052			
53	Short bolt	16.10PCB1423053			

POWERTEX Chain Block PCB-S1 – Spare parts 20 t

When ordering spare parts, specify model, WLL, part number and the quantity needed.

When ordering chain, also specify lifting height.

If the load chain has been damaged or worn out the load sheave probably has to be replaced.

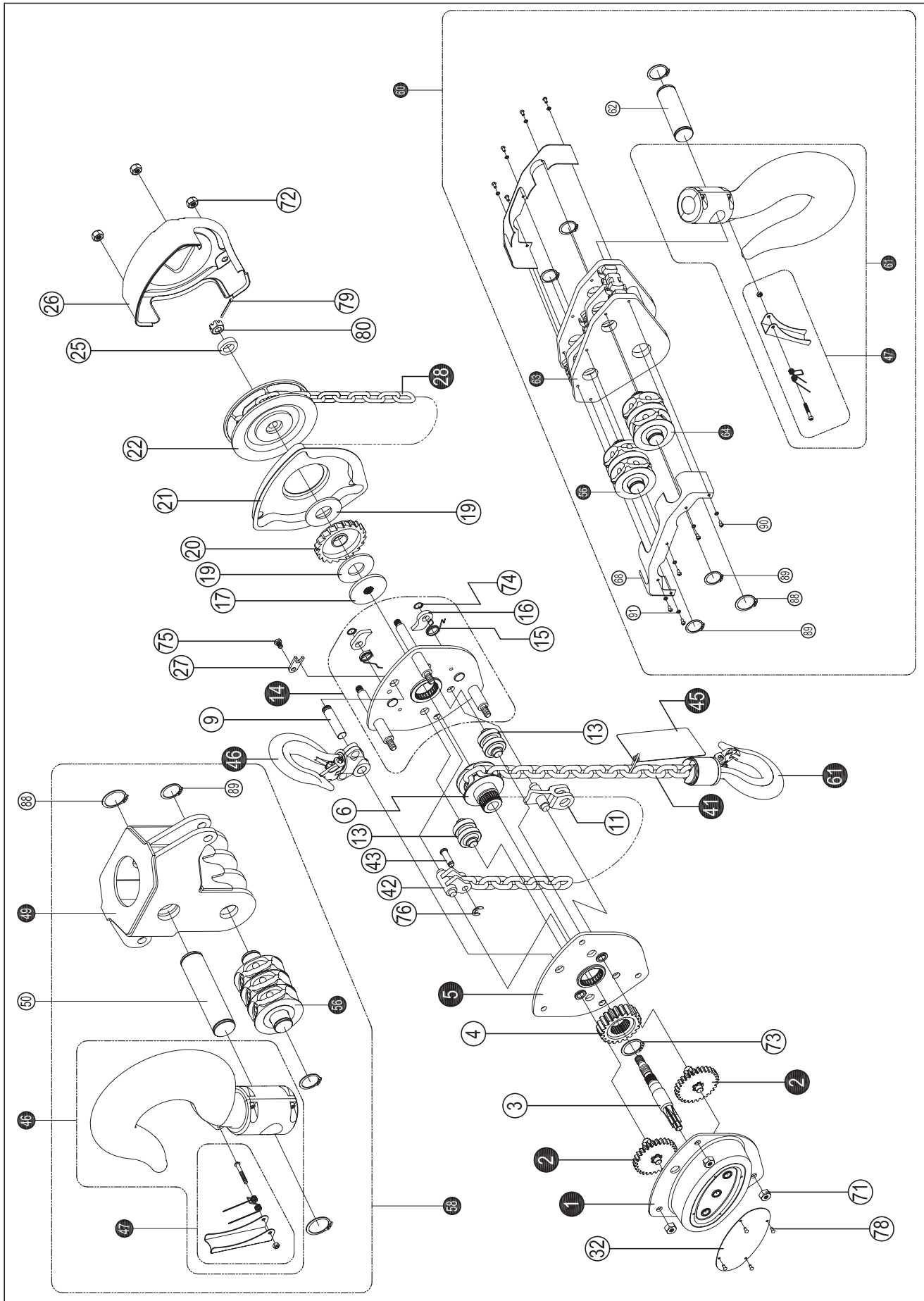

Spare parts list 20 t

Pos	Description	20 t
1	Gear cover assy	16.10PCB1427001
2	Disc gear assy	16.10PCB1427002
3	Drive shaft	16.10PCB1427003
4	Splined gear	16.10PCB1427004
5	Right side plate assy	16.10PCB1427005
6	Load chain sprocket	16.10PCB1427006
9	Top hook shaft	16.10PCB1427009
11	Chain stripper	16.10PCB1427011
13	Guide roller	16.10PCB1427013
14	Left side plate assy	16.10PCB1427014
15	Pawl spring	16.10PCB1427015
16	Pawl	16.10PCB1427016
17	Brake seat	16.10PCB1427017
19	Friction plate	16.10PCB1427019
20	Ratchet wheel	16.10PCB1427020
21	Brake cover	16.10PCB1427021
22	Hand chain wheel	16.10PCB1427022
25	Washer	16.10PCB1427025
26	Hand chain cover	16.10PCB1427026
27	Positioned plate	16.10PCB1427027
28	Hand chain 5x23.7 mm	16.10PCB1427028
32	Name plate	16.10PCB1427032
41	Load chain 9x27 mm	16.10PCB1427041
42	End anchor	16.10PCB1427042
43	End anchor pin	16.10PCB1427043
46	Hook assy	16.10PCB1427046
47	Safety latch assy	16.10PCB1427047
49	Beam for top hook	16.10PCB1427049
50	Shaft for top hook	16.10PCB1427050
51	Plate (left)	16.10PCB1427051
52	Stay bolt A	16.10PCB1427052
53	Short bolt	16.10PCB1427053
56	Idler sheave assy	16.10PCB1427056
58	Top hook assy	16.10PCB1427058
60	Bottom hook assy	16.10PCB1427060
61	Hook assy	16.10PCB1427062
63	Bottom hook connector assy	16.10PCB1427063
64	Idler sheave assy for bottom hook	16.10PCB1427064
68	Protection cover	16.10PCB1427068
88	External circlips	16.10PCB1427088
89	External circlips	16.10PCB1427089
90	Cross recessed countersunk head screws	16.10PCB1427090
91	Light spring washer	16.10PCB1427091



SVERO AB
Momariken 19
556 50 Jönköping Sweden

CERTEX Lifting KnowHow app

Download The Lifting KnowHow app'en from the App Store / Google play!

The App has the following features:

- Load charts for different types of lifting slings
- Protractor for measuring sling angles
- Instructions for safe use of a selection of lifting gear
- Built-in gps function that finds the Lifting Solutions Group office closest to your position.
- And a lot more.

The Lifting KnowHow is a unique knowledge transfer programme.



CertMax+

The CertMax+ system is a unique leading edge certification management system which is ideal for managing a single asset or large equipment portfolio across multiple sites. Designed by the Lifting Solutions Group, to deliver optimum asset integrity, quality assurance and traceability, the system also improves safety and risk management levels.



Marking

The POWERTEX Chain Block is equipped with a RFID (Radio-Frequency Identification) tag, which is a small electronic device, that consist of a small chip and an antenna. It provides a unique identifier for the block.

The POWERTEX Chain Block is **CE** marked

Standard: EN 13157



Warning tag

The warning tag shows some specific and important situations, in which you must pay special attention, when using POWERTEX Chain Blocks and Lever Hoists.



User Manuals

You can always find the valid and updated User Manuals on the web. The manual is updated continuously and valid only in the latest version.

NB! The English version is the Original instruction.

The manual is available as a download under the following link:
www.powertex-products.com/manuals



POWERTEX



The Lifting KnowHow



www.powertex-products.com